







13 801 845



- 210mm projection
- circular normal flow
- hole diameter 37 mm
- 1/2" connection
- plug-link mounting
- max. flow 21.5 l/min at 3 bar flow pressure
- WRAS 2207003

| | | |
|-----------------------------------------------------------------------------------|-----------------------|---------------|
|  | Brushed Chrome | 13 801 845-93 |
|  | Chrome | 13 801 845-00 |
|  | Brushed Platinum | 13 801 845-06 |
|  | Dark Chrome | 13 801 845-19 |
|  | Matte Black | 13 801 845-33 |
|  | Brushed Dark Platinum | 13 801 845-99 |

13 801 845

mm [inches]



Flow rate chart

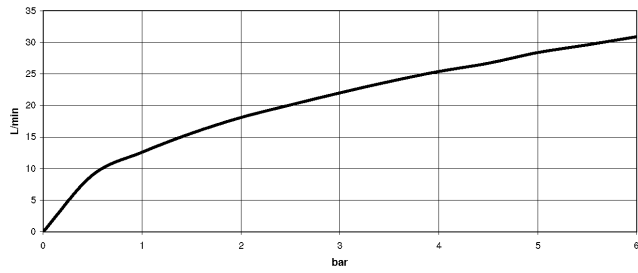

Certificates

IAPMO_4976 (2). LGA_29012. WRAS_2207003.

13 801 845

Parts for other finishes can be found here: [Chrome](#)

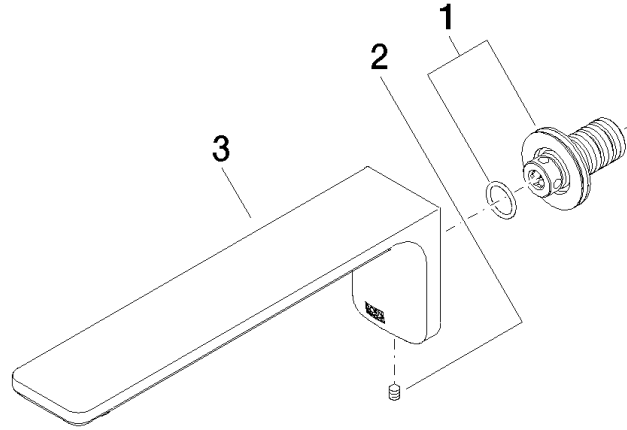

Spare parts list

| No. | Item Number | Name | Quantity used | Delivery time |
|-----|--------------------|------------|---------------|---------------|
| 1 | 90 24 03 108 00 90 | nipple set | 1 | 2 |
| 2 | 90 31 11 004 00 90 | pin | 1 | 2 |
| 3 | 90 11 84 014 02-93 | spout | 1 | 20 |